

PLUS - Static Preparation 1100 mm Work Table with Upstand and with Lower Shelf

ITEM # _____

MODEL # _____

NAME # _____

SIS # _____

AIA # _____

134094 (LSGTG1110E)

 Work Table with lower shelf
 and upstand, 1100mm

Short Form Specification

Item No.

Enhanced stability and solid construction thanks to the welded frame and legs. The 50mm high worktop in 304 AISI stainless steel, with Scotch Brite finishing 15/10 mm in thickness, has anti-drip edges and welded corners. 18mm thick undertop reinforced worktop, it's completely waterproof, double-sided laminated and 100% recyclable. Upstand h=100mm with 10mm radius corner covered on the back with AISI 304 stainless steel spot welded profile. 40 mm-thick lower welded shelf in AISI 304 stainless steel slots easily into place at a height of 200 mm from the floor (compulsory to install the chest of drawers). Square section legs and height adjustable feet (-20/+30 mm) in 304 AISI stainless steel.

Main Features

- Enhanced stability and solid construction. Stability, loading and stress tests by external certified body.
- Product range suitable for international tenders requirements for intense usage installations.

Construction

- Welded frame and legs.
- Worktop with 50 mm high profile, in s/s Scotch Brite finishing, 15/10 in thickness with anti-drip edges and welded corners.
- Constructed entirely in 304 AISI stainless steel.
- Undertop is 18mm in thickness, reinforced, completely waterproof, double-sided laminated and 100% recyclable.
- Upstand back completely covered with Stainless Steel welded profile.
- Lower shelf has 40mm high profile, is 8/10 in thickness with upturned edges and bar reinforcement welded to legs for further structure reinforcement.
- Square section legs (40x40mm, 10/10 in thickness) and height-adjustable feet (-20/+30mm).
- Accessories: -drawers are easily accessible thanks to the fully extractable guides, completely in stainless steel. Rounded corners facilitate cleaning and improve hygiene, they can be installed in any position under the top and can hold GN containers with a maximum height of 100mm. Ergonomic stainless steel handle and fluently sliding guides. -single drawer and chest of 4 drawers are available in 400mm (suitable for 1/1 GN containers) or 600mm sizes. -chest of drawers available only for models with lower shelf. -set of castors as alternative to the feet, can be fitted as optional.

Optional Accessories

- Drawer for 1/1GN container, 400mm PNC 855201
- Drawer 600X650X150mm PNC 855202
- Chest of 4 drawers for 1/1G, 400mm PNC 855203
- Chest of 4 drawers, 600mm PNC 855204
- Set of 4 wheels (2 with brake), diameter=100mm PNC 855205

APPROVAL: _____

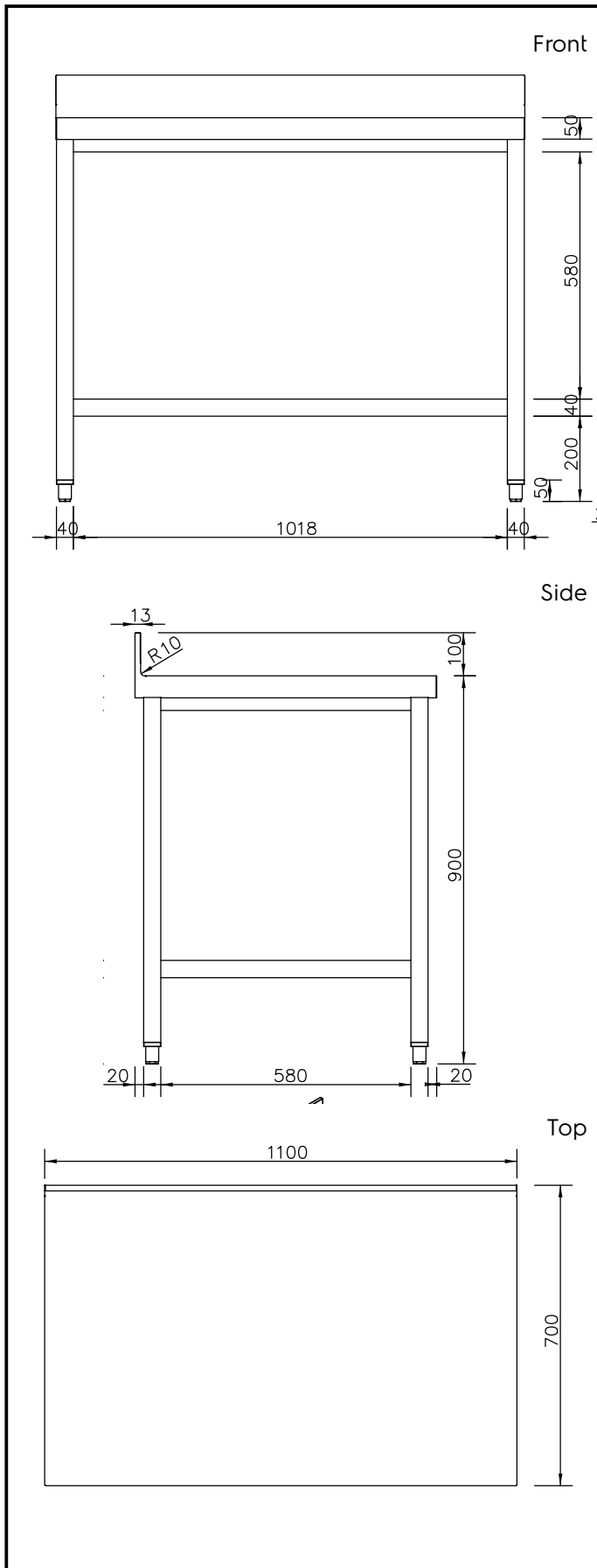

Key Information:

Drawer combinations - No.

400 mm drawers
 134094 (LSGTG1110E) 2

Drawer combinations -
 No.600 mm drawers 1

External dimensions, Width: 1100 mm

External dimensions, Depth: 700 mm

External dimensions, Height: 1000 mm

Upstand Dimensions, Height: 100 mm

Upstand Dimensions, Depth: 13 mm

Upstand Dimensions, Radius: R=10

Worktop thickness: 50 mm

Net weight: 40 kg